

EUROVENT<sup>□</sup> EUROVENT<sup>□</sup> EUROVENT<sup>□</sup> EUROVENT<sup>□</sup> EUROVENT<sup>□</sup>

EUROVENT<sup>□</sup> EUROVENT<sup>□</sup> EUROVENT<sup>□</sup> EUROVENT<sup>□</sup>

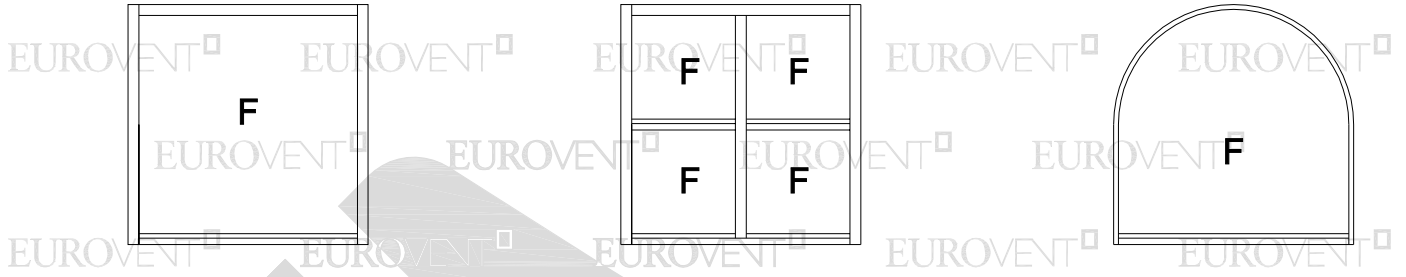

EUROVENT<sup>□</sup> EUROVENT<sup>□</sup> EUROVENT<sup>□</sup> EUROVENT<sup>□</sup>

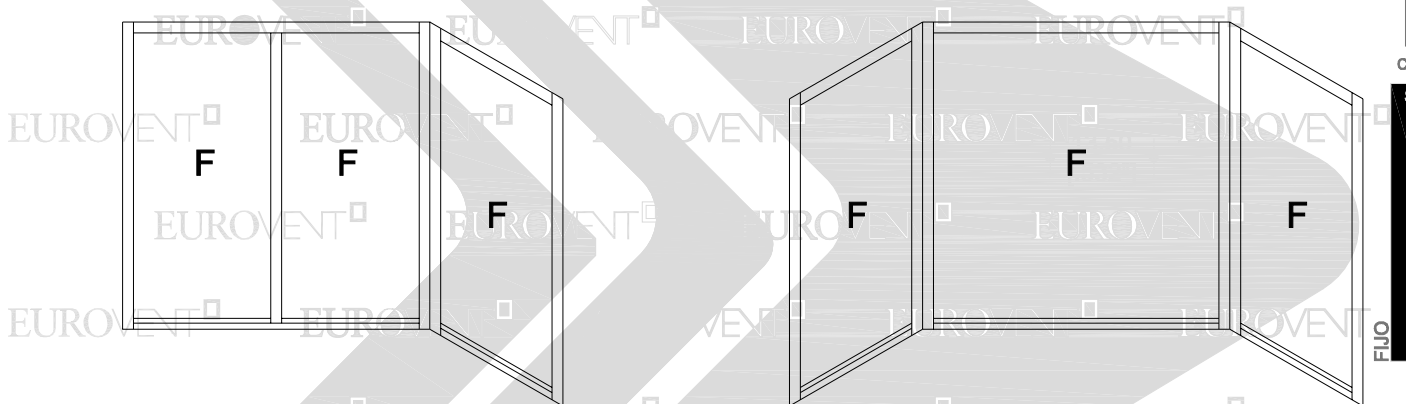

CLASSIC  
SERIE  
**S35**  
FIJO

EUROVENT<sup>□</sup> EUROVENT<sup>□</sup> EUROVENT<sup>□</sup> EUROVENT<sup>□</sup>

EUROVENT<sup>□</sup> EUROVENT<sup>□</sup> EUROVENT<sup>□</sup> EUROVENT<sup>□</sup>

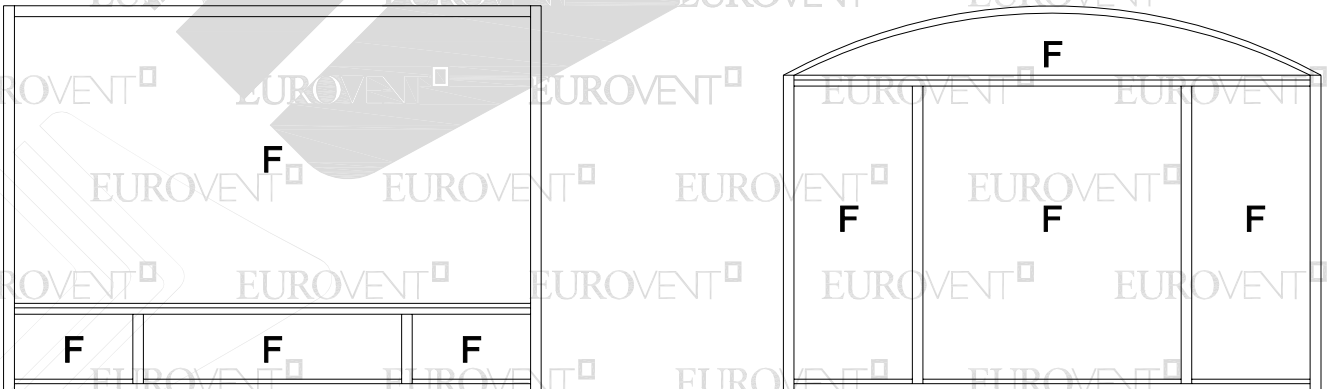

EUROVENT EUROVENT EUROVENT EUROVENT EUROVENT

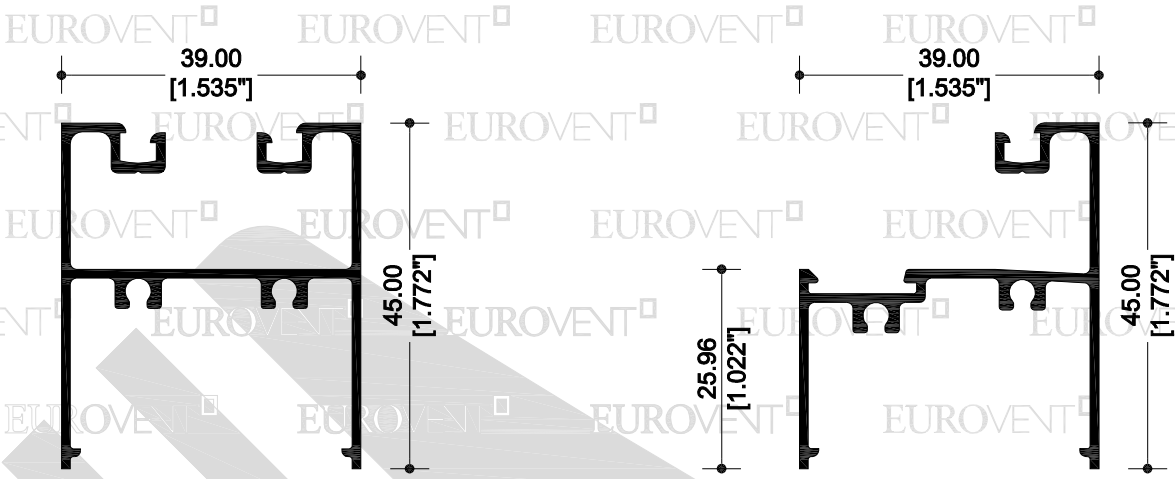

**12606**  
BOLSA

**12608**  
ESCALONADO

EUROVENT EUROVENT EUROVENT EUROVENT EUROVENT

EUROVENT EUROVENT EUROVENT EUROVENT EUROVENT



**12607**  
TAPA BOLSA

**12609**  
JUNQUILLO

EUROVENT EUROVENT EUROVENT EUROVENT EUROVENT

EUROVENT EUROVENT EUROVENT EUROVENT EUROVENT

EUROVENT EUROVENT EUROVENT EUROVENT EUROVENT

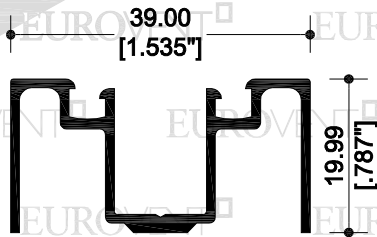

**12694**  
BOLSA CORTA

EUROVENT EUROVENT EUROVENT EUROVENT EUROVENT

EUROVENT<sup>®</sup> EUROVENT<sup>®</sup> EUROVENT<sup>®</sup> EUROVENT<sup>®</sup> EUROVENT<sup>®</sup>

39.00 [1.535"] 39.00 [1.535"]

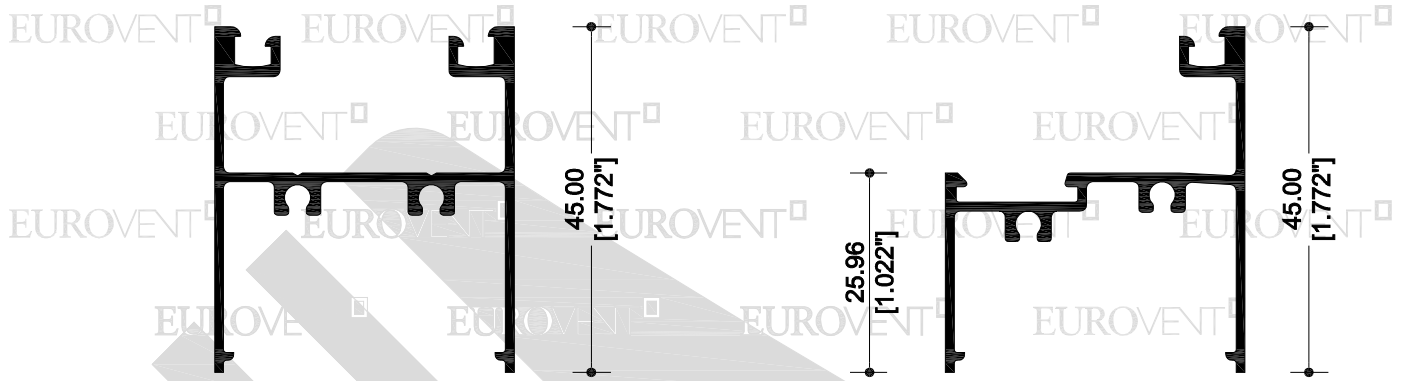

**12613**  
BOLSA

**12614**  
ESCALONADO

39.00 [1.535"] 17.12 [0.674"]



**14388**  
TAPA BOLSA

**12603**  
JUNQUILLO 18mm

39.00 [1.535"]

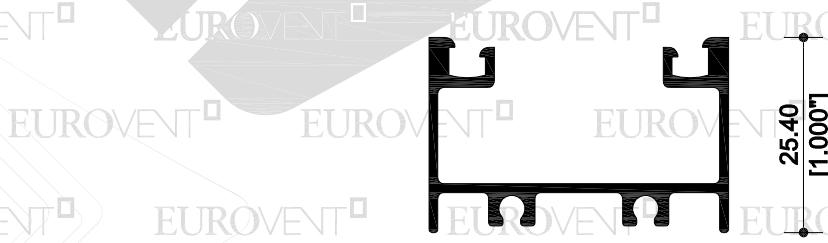

**14428**  
BOLSA CORTA

CLASSIC  
SERIE

**S35**

FIJO

EUROVENT EUROVENT EUROVENT EUROVENT EUROVENT

EUROVENT EUROVENT EUROVENT EUROVENT

EUROVENT EUROVENT EUROVENT EUROVENT EUROVENT

EUROVENT EUROVENT EUROVENT EUROVENT

EUROVENT EUROVENT EUROVENT EUROVENT

EUROVENT EUROVENT EUROVENT EUROVENT

EUROVENT EUROVENT EUROVENT EUROVENT

EUROVENT EUROVENT EUROVENT EUROVENT

EUROVENT EUROVENT EUROVENT EUROVENT

EUROVENT EUROVENT EUROVENT EUROVENT

EUROVENT EUROVENT EUROVENT EUROVENT

EUROVENT EUROVENT EUROVENT EUROVENT

EUROVENT EUROVENT EUROVENT EUROVENT

EUROVENT EUROVENT EUROVENT EUROVENT

EUROVENT EUROVENT EUROVENT EUROVENT

EUROVENT EUROVENT EUROVENT EUROVENT

EUROVENT EUROVENT EUROVENT EUROVENT

EUROVENT EUROVENT EUROVENT EUROVENT

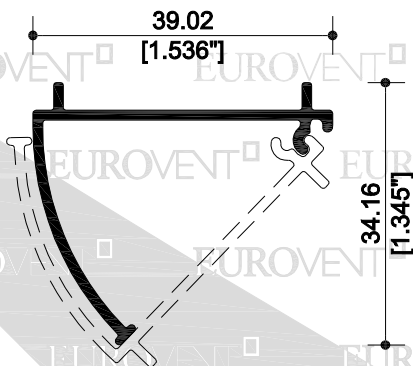

**62135**  
ESQ. REGULABLE  
AUTO-ENSAMBLE



SERIE

S35

FIJO

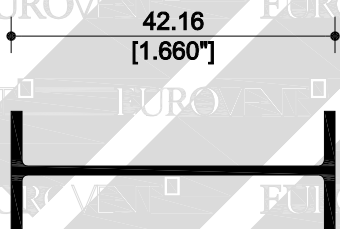

**12622**  
MOLDURA DE UNIÓN



**12796**  
TAPA LISA

# EUROVENT<sup>□</sup> FIJO SERIE 35 - ELEVACIONES Y CORTES SECCIONALES

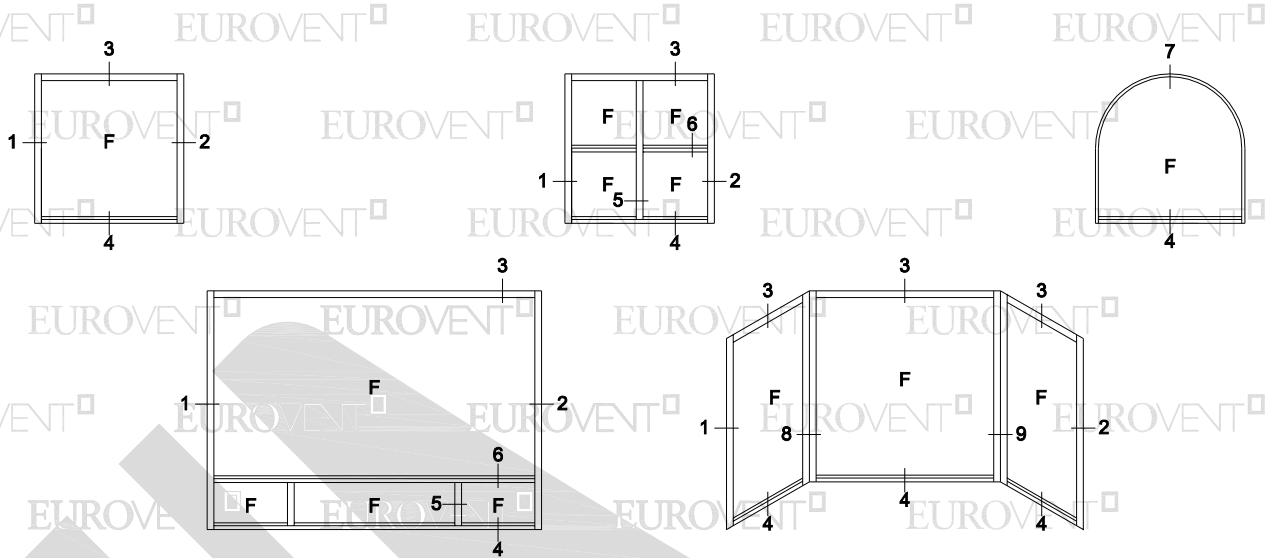

ELEVACIONES TIPO

SIN ESCALA

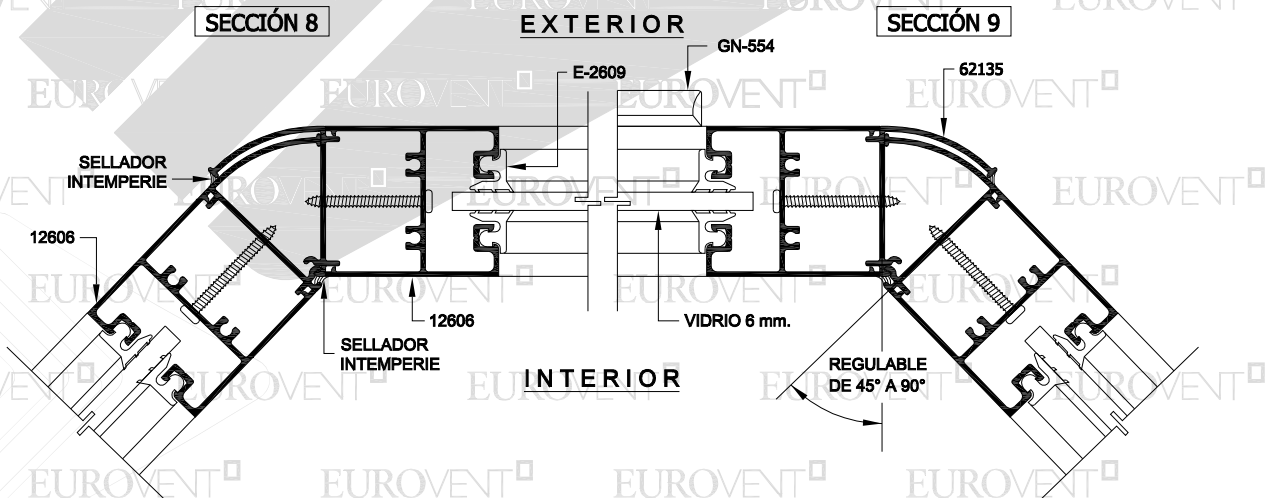
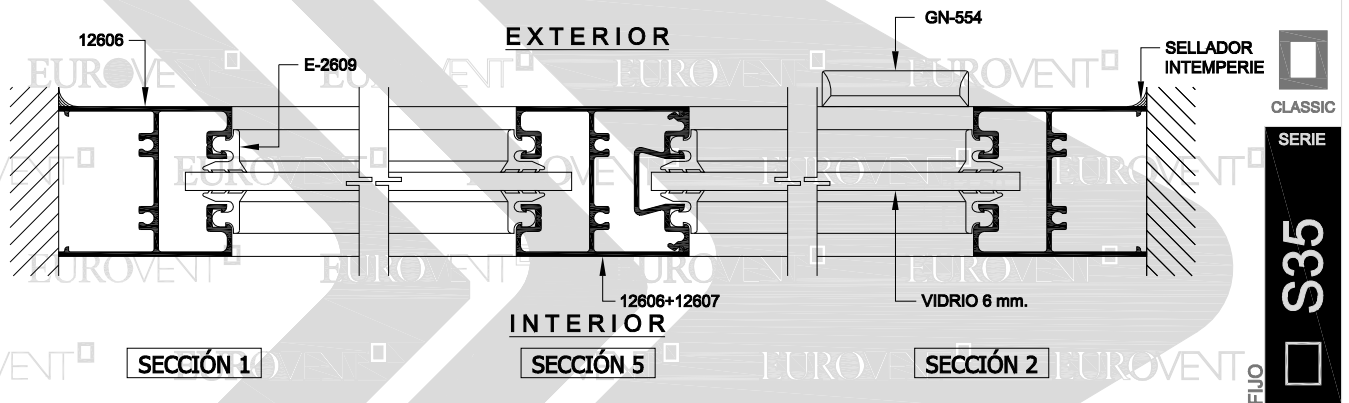

EUROVENT EUROVENT EUROVENT EUROVENT EUROVENT

EUROVENT EUROVENT EUROVENT EUROVENT EUROVENT

EUROVENT EUROVENT EUROVENT EUROVENT EUROVENT

EUROVENT EUROVENT EUROVENT EUROVENT EUROVENT

EUROVENT EUROVENT EUROVENT EUROVENT EUROVENT

EUROVENT EUROVENT EUROVENT EUROVENT EUROVENT

EUROVENT EUROVENT EUROVENT EUROVENT EUROVENT

EUROVENT EUROVENT EUROVENT EUROVENT EUROVENT

EUROVENT EUROVENT EUROVENT EUROVENT EUROVENT

EUROVENT EUROVENT EUROVENT EUROVENT EUROVENT

EUROVENT EUROVENT EUROVENT EUROVENT EUROVENT

EUROVENT EUROVENT EUROVENT EUROVENT EUROVENT

EUROVENT EUROVENT EUROVENT EUROVENT EUROVENT

EUROVENT EUROVENT EUROVENT EUROVENT EUROVENT

EUROVENT EUROVENT EUROVENT EUROVENT EUROVENT

EUROVENT EUROVENT EUROVENT EUROVENT EUROVENT

EUROVENT EUROVENT EUROVENT EUROVENT EUROVENT

EUROVENT EUROVENT EUROVENT EUROVENT EUROVENT

SELLADOR  
INTEMPERIE

12606

SECCIÓN 3

E-2609

VIDRIO 6 mm.

SECCIÓN 6

EXTERIOR

INTERIOR

12608+12607+12609

SECCIÓN 7

12694

E-2609

VIDRIO 6 mm.

EXTERIOR

INTERIOR

SECCIÓN 4

CALZA

GN-554

SELLADOR  
INTEMPERIE

12609

12608

SECCIÓN 4

CALZA

GN-554

12609

12608



CLASSIC

SERIE

S35



FIJO



# EUROVENT<sup>□</sup> FIJO SERIE 35 - DOBLE VIDRIO ELEVACIONES Y CORTES

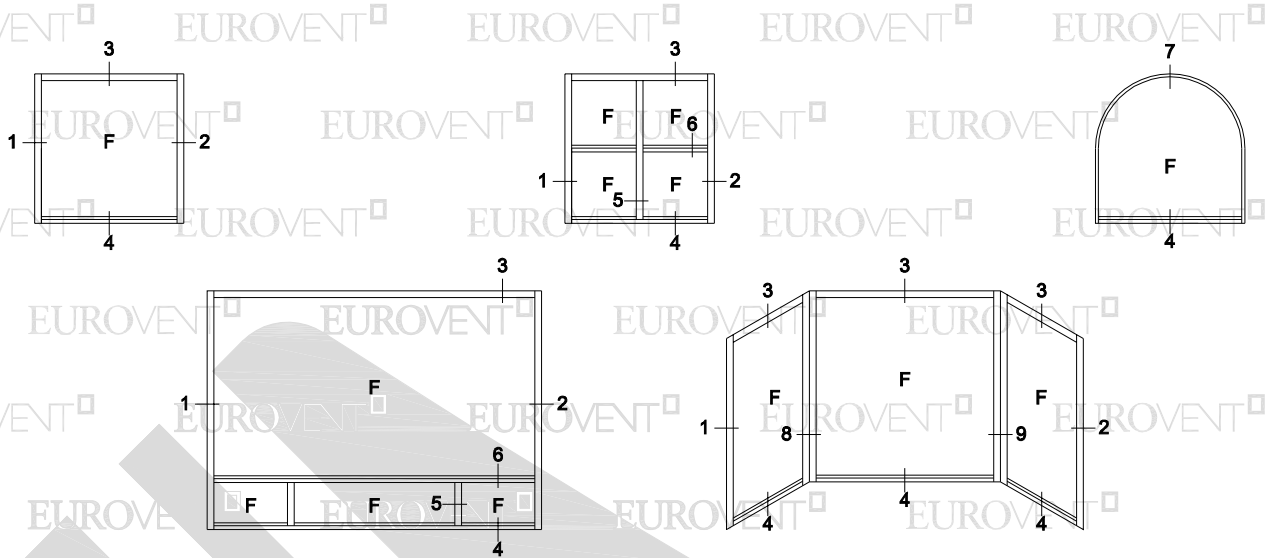

ELEVACIONES TIPO

SIN ESCALA

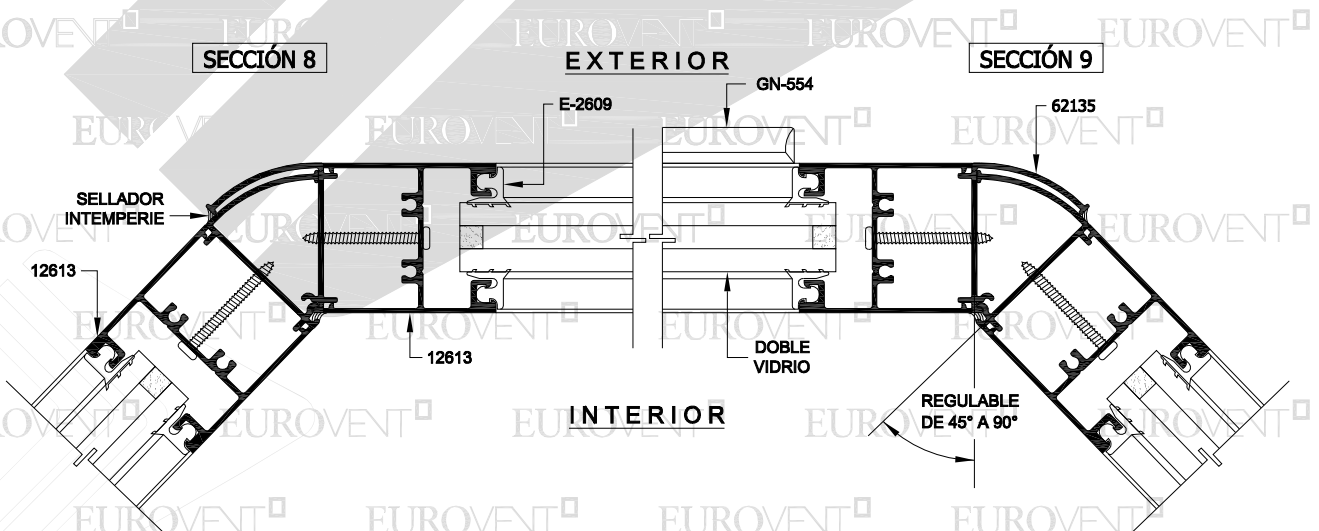
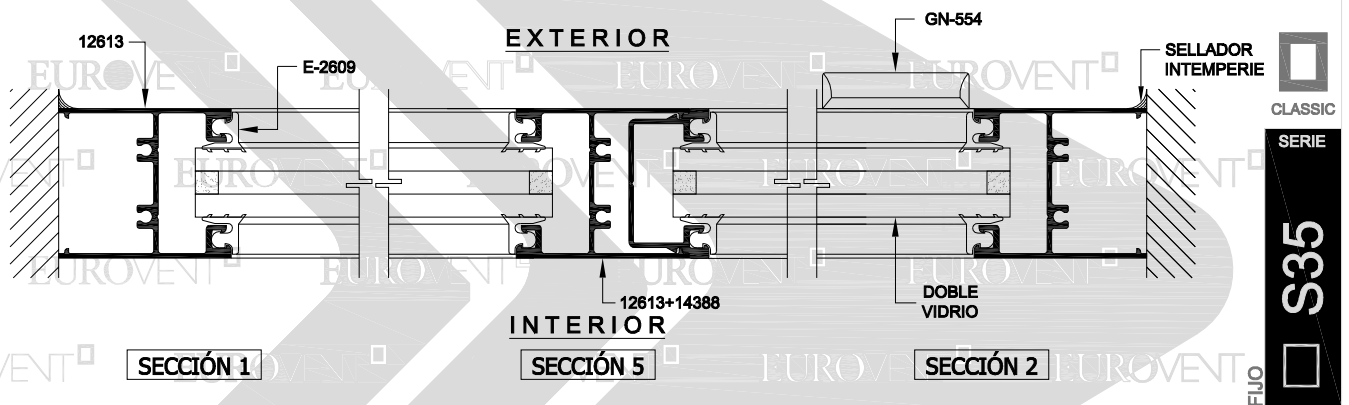

EUROVENT EUROVENT EUROVENT EUROVENT EUROVENT

EUROVENT EUROVENT EUROVENT EUROVENT

EUROVENT EUROVENT EUROVENT EUROVENT

EUROVENT EUROVENT EUROVENT EUROVENT

EUROVENT EUROVENT EUROVENT EUROVENT

EUROVENT EUROVENT EUROVENT EUROVENT

EUROVENT EUROVENT EUROVENT EUROVENT

EUROVENT EUROVENT EUROVENT EUROVENT

EUROVENT EUROVENT EUROVENT EUROVENT

EUROVENT EUROVENT EUROVENT EUROVENT

EUROVENT EUROVENT EUROVENT EUROVENT

EUROVENT EUROVENT EUROVENT EUROVENT

EUROVENT EUROVENT EUROVENT EUROVENT

EUROVENT EUROVENT EUROVENT EUROVENT

EUROVENT EUROVENT EUROVENT EUROVENT

EUROVENT EUROVENT EUROVENT EUROVENT

EUROVENT EUROVENT EUROVENT EUROVENT

EUROVENT EUROVENT EUROVENT EUROVENT

EUROVENT EUROVENT EUROVENT EUROVENT

EUROVENT EUROVENT EUROVENT EUROVENT

EUROVENT EUROVENT EUROVENT EUROVENT

EUROVENT EUROVENT EUROVENT EUROVENT

EUROVENT EUROVENT EUROVENT EUROVENT

EUROVENT EUROVENT EUROVENT EUROVENT

EUROVENT EUROVENT EUROVENT EUROVENT

EUROVENT EUROVENT EUROVENT EUROVENT

EUROVENT EUROVENT EUROVENT EUROVENT

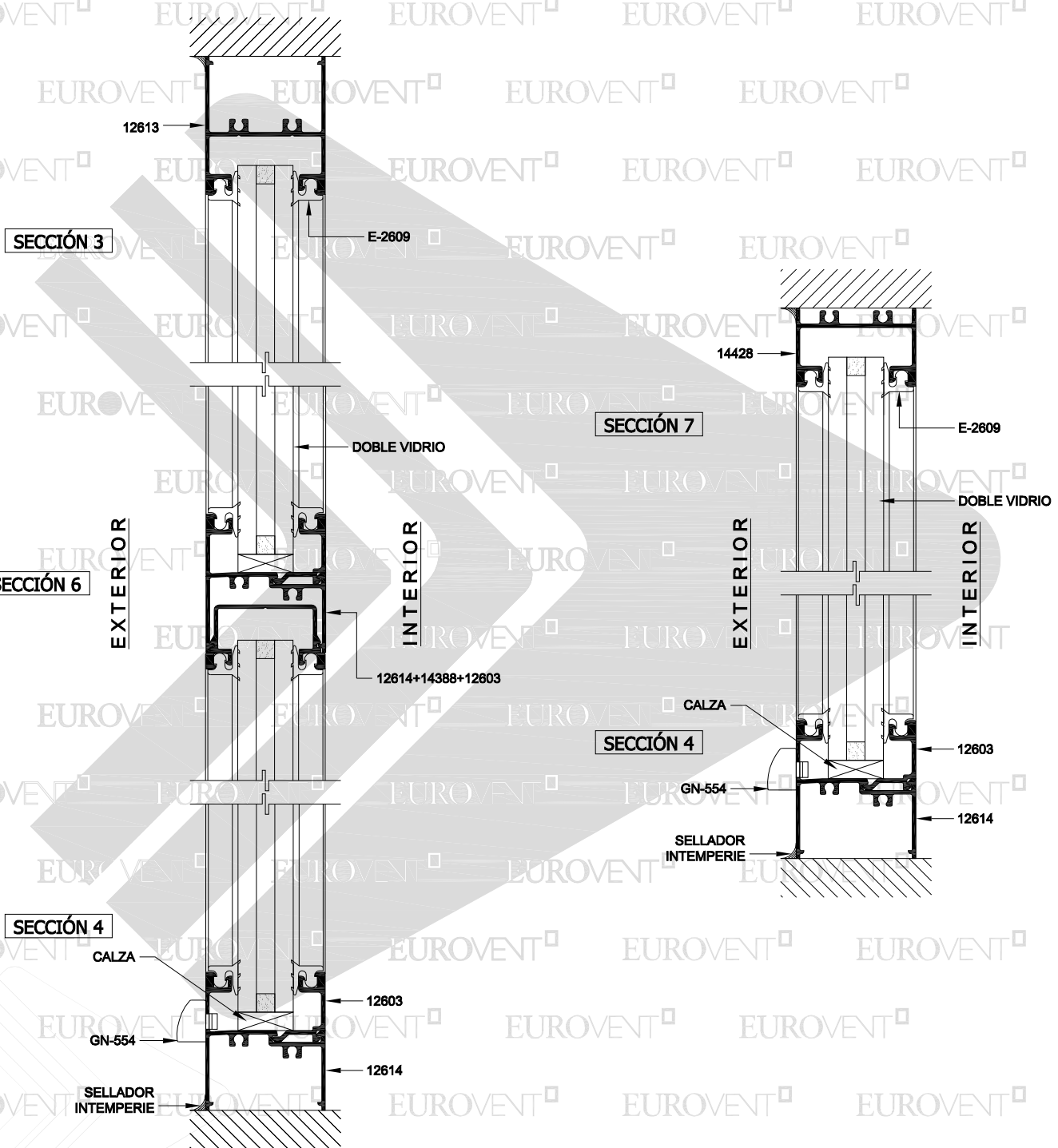

CLASSIC  
SERIE  
**S35**  
FIJO



DREN PARA DESAGÜE

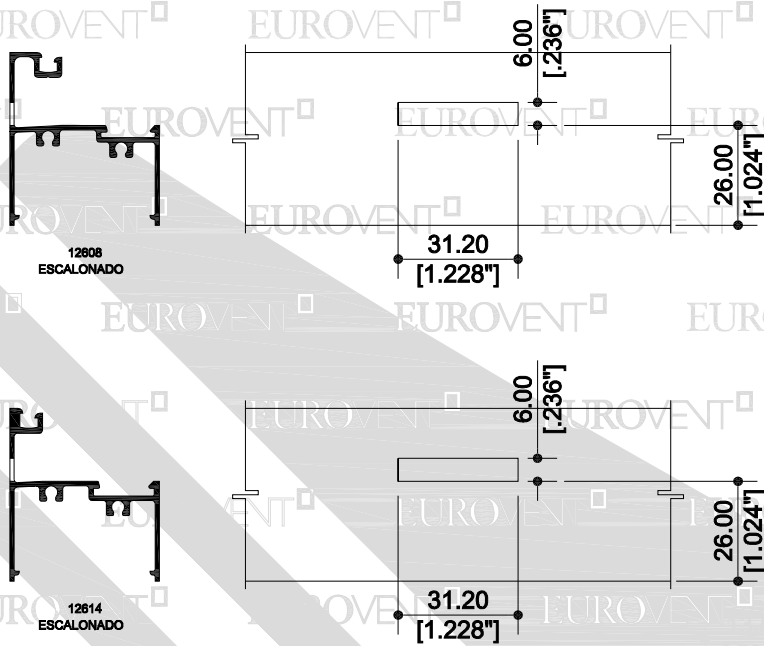

CLASSIC  
SERIE

S35

FIJO

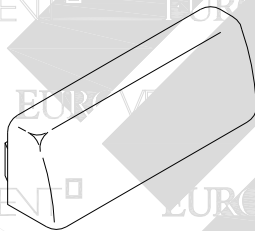

**GN-554**  
TAPA DREN

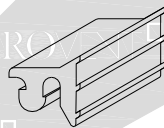

**E-2609**  
EMPAQUE



**PIJA**  
#8x2"

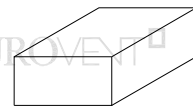

**CALZA DE NEOPRENO**  
1/2" x 1/4"

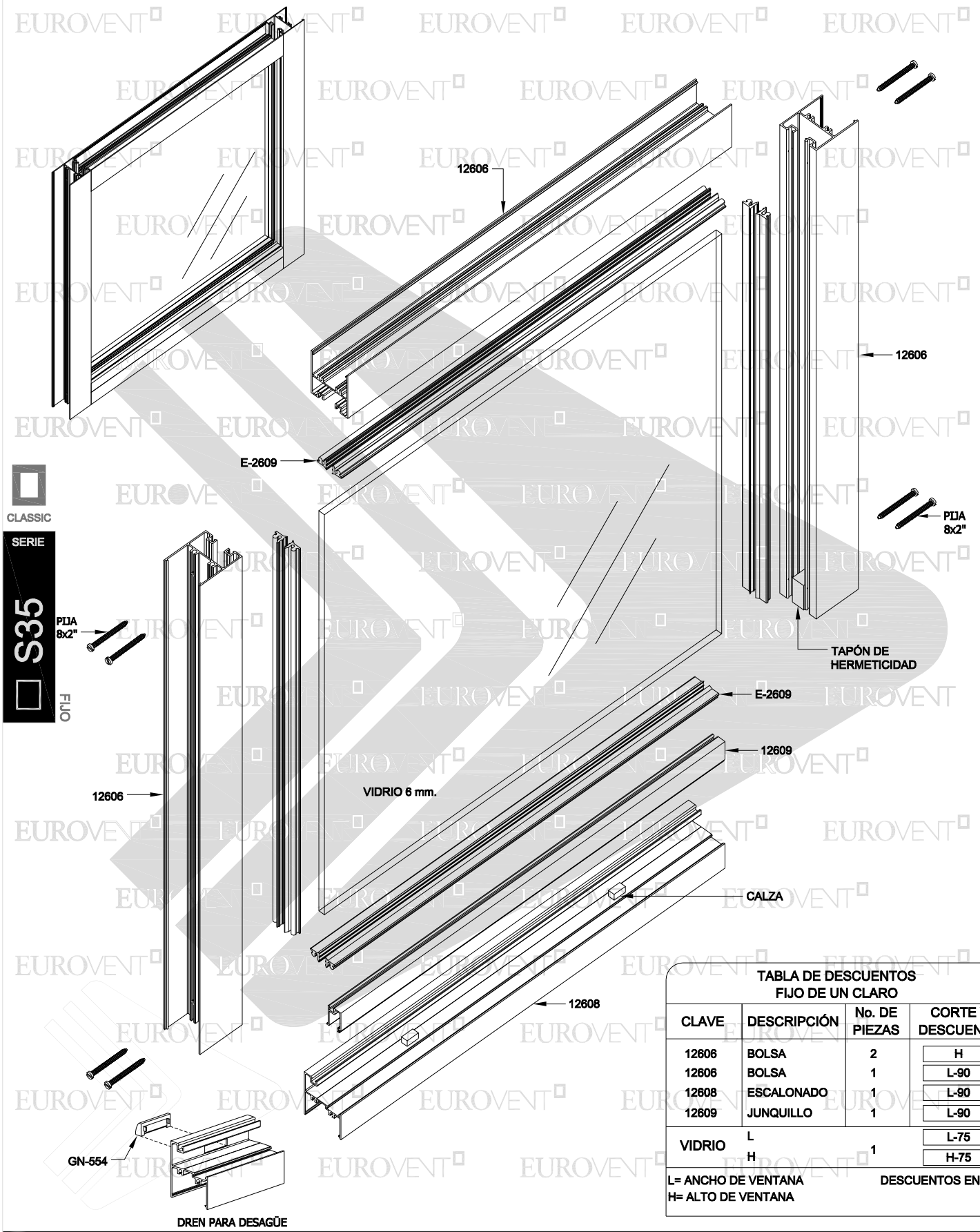

CLASSIC  
SERIE  
**S35**  
FIJO

**TABLA DE DESCUENTOS FIJO DE UN CLARO**

CLAVE	DESCRIPCIÓN	No. DE PIEZAS	CORTE Y DESCUENTO
12606	BOLSA	2	H
12606	BOLSA	1	L-90
12608	ESCALONADO	1	L-90
12609	JUNQUILLO	1	L-90
VIDRIO	L	1	L-75
	H		H-75

L= ANCHO DE VENTANA  
H= ALTO DE VENTANA  
DESCUENTOS EN MM.

DEFLEXIÓN MAX. L/175

FIJO SERIE 35

FIJO SERIE 35 (DOBLE VIDRIO)

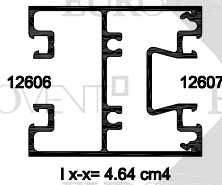
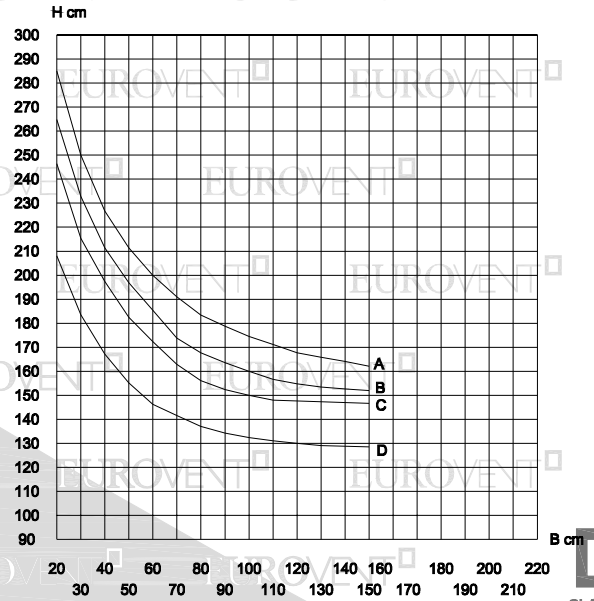
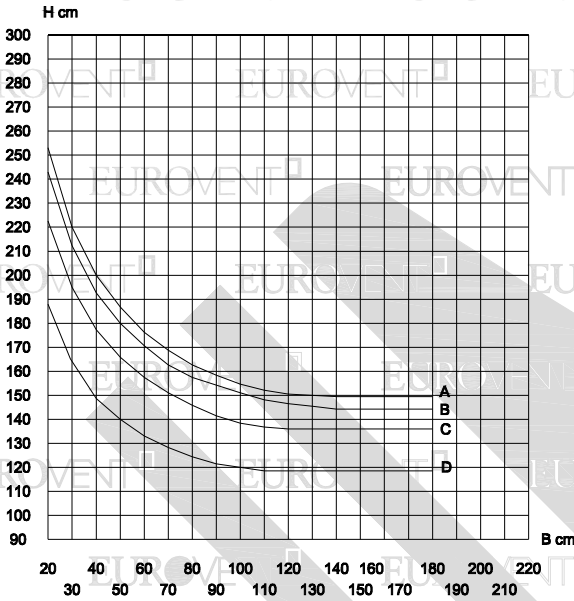

LOS LÍMITES DE FABRICACIÓN PARA LOS PERFILES, SERÁN LOS QUE SE ENCUENTREN DEBAJO DE LAS CURVAS GRAFICADAS.

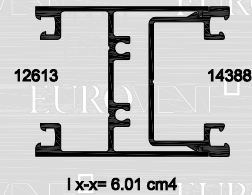

ALEACIÓN: 6063  
TEMPLE: 5

Valores de presión por velocidad de viento

Curvas	Presión del diseño	Velocidad de viento	Zona
A	45 Kg/m <sup>2</sup>	80 Km/h	Centro de grandes ciudades
B	50 Kg/m <sup>2</sup>	90 Km/h	Barrios Residenciales
C	65 Kg/m <sup>2</sup>	120 Km/h	Campo Abierto
D	110 Kg/m <sup>2</sup>	160 Km/h	Zona Costera

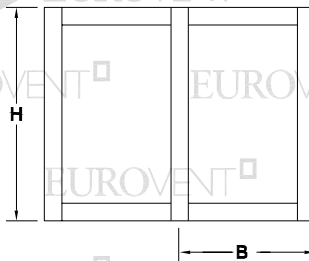

LOS LÍMITES DE UN CANCEL VAN EN FUNCIÓN DE LA COMBINACIÓN DE RESISTENCIA DEL PERFIL DE ALUMINIO, EL VIDRIO Y LOS ACCESORIOS QUE LO INTEGRAN.

VERIFICAR QUE LA DEFLEXIÓN DEL PERFIL SEA COMPATIBLE CON EL VIDRIO UTILIZADO.



**PARÁMETROS MÍNIMOS Y MÁXIMOS DE FABRICACIÓN.**

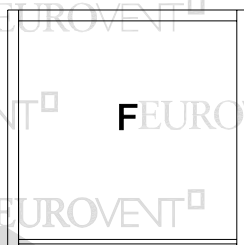

F-35

MÍNIMO 0.30 x 0.30  
 MÁXIMO 4m<sup>2</sup> CON VIDRIO RECOCIDO DE 6 mm. SIN INTERMEDIOS,  
 PARA OTROS ESPESORES VER CON EL FABRICANTE,  
 CON INTERMEDIOS VER GRÁFICA.

CLASSIC  
 SERIE  
**S35**  
 FIJO

ALUMINIO					
CLAVE	DESCRIPCIÓN	PIEZAS X ATADO	LARGO STD. MTS.	PERÍMETRO ANOD. CM.	PERÍMETRO PUL. CM.
12603	JUNQUILLO	20	6.10	10.47	2.30
12606	BOLSA	8	6.10	37.33	10.82
12607	TAPA BOLSA	16	6.10	16.72	1.91
12608	ESCALONADO	8	6.10	30.23	8.61
12609	JUNQUILLO	20	6.10	12.91	2.81
12613	BOLSA	8	6.10	33.62	9.82
12614	ESCALONADO	8	6.10	28.42	8.14
12622	MOLDURA DE UNIÓN	16	6.10	14.21	3.63
12694	BOLSA CORTA	10	6.10	24.08	5.79
12796	TAPA LISA	40	6.10	9.28	3.64
14388	TAPA BOLSA	12	6.10	19.39	0.76
14428	BOLSA CORTA	8	6.10	25.26	6.08
62135	ESQ. REGULABLE	17	6.10	17.09	4.01